

Характеристики

Входное давление	Max. 60 bar
Применение	Compressed air and other neutral, non-flammable gases
Рабочая температура	-10 °C to +90 °C
Уплотнение	Нитрильный каучук
Материал	Латунь
Измерение расхода воздуха	At P1 = 20 bar, P2 = 10 bar and pressure drop $\Delta p = 4$ bar

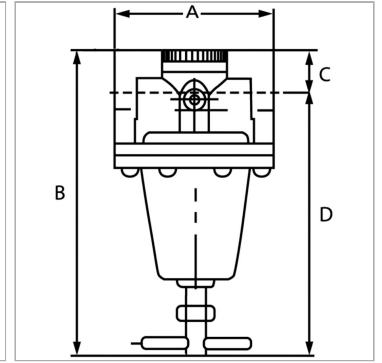

Информация о продукте

Резьба	G 3/8
Диапазон регулирования	2 - 50 bar
Расход пот.	1400 l/min
C	31 mm

C	31 mm
A	72 mm
B	164,0 mm
D	133 mm

Указания

Прочие данные только по запросу.

Описание

Reversible piston-type pressure regulator, virtually independent of inlet pressure, with self-relieving design, manufactured entirely in brass. Specially designed for high pressures up to 60 bar. Pressure catch with counter nut.