

Filter regulators with polycarbonate bowl and pressure gauge

Характеристики

Входное давление	Max. 16 bar (polycarbonate bowl), Max. 20 bar (metal bowl)
Температура среды	max. 50 °C
Температура окружающей среды	Max. 50 °C (polycarbonate bowl), Max. 80 °C (metal bowl)
Уплотнение	Нитрильный каучук
Размер пор в фильтрующем элементе	40 µm
Мембрана	NBR
Корпус	Die-cast zinc
Пружинная крышка	POM
Drain valve	Manual
Измерение расхода воздуха	At P1 = 10 bar, P2 = 6 bar and pressure drop $\Delta p = 1$ bar
Дополнительная информация	Filterregler sind auch mit Schutzkorb oder Metallbehälter lieferbar. Filterregler sind auch in abschließbarer Ausführung lieferbar. Bitte anfragen.

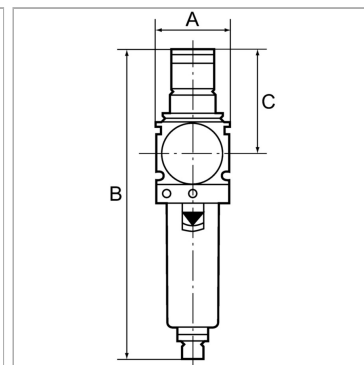

Информация о продукте

Резьба	G 3/4
Диапазон регулирования	0.5 - 10 bar
Расход пот.	6500 l/min

C	98 mm
A	70 mm
B	273,0 mm

Указания

Прочие данные только по запросу.

Описание

Reversible diaphragm pressure regulators, independent of inlet pressure, with self-relieving design, combined with a centrifugal separator. The pressure setting can be locked by pushing the knob down. Approved series in modern industrial design, with the following key benefits: Simple handling, Convenient modular assembly thanks to innovative fasteners, Excellent flow values.

Указание по заказу

Filter regulators are also available with bowl guard or metal bowl. Filter regulators are also available in lockable version. Please ask for more information.

Дополнительная информация

Filter regulators are also available with bowl guard or metal bowl. Filter regulators are also available in lockable version. Please ask for more information.