

Характеристики

Входное давление	Max. 40 bar
Область температур	+5 °C to +90 °C
Уплотнение	Нитрильный каучук
Мембрана	NBR
Корпус	Brass
маховик	Plastic (G 1/4, G 1/2), rotary switch (G 3/4, G 1)
Измерение расхода воздуха	At P1 = 7 bar, P2 = 6 bar and $\Delta p = 1$ bar

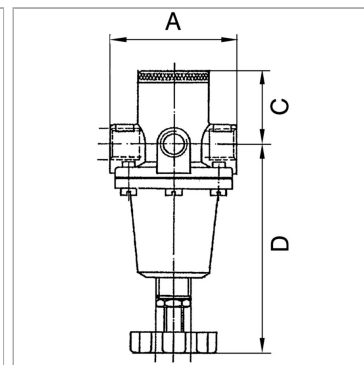

Информация о продукте

Резьба	G 1/2
Диапазон регулирования	0.5 - 6 bar
Расход пот.	15 l/min
C	30 mm

C	30 mm
A	72 mm
B	153,0 mm
D	123 mm

Указания

Прочие данные только по запросу.

Описание

Brass diaphragm pressure regulators with non-self-relieving design, specially for use with water. The regulator protects water installations against high system pressure, prevents pressure fluctuations and helps reduce water consumption. Undesirable flow noises are kept to a minimum.