

Pressure regulators with pressure supply at both ends

Обновлено: 04.17.24

Характеристики

Входное давление	Max. 25 bar
Температура окружающей среды	max. 50 °C
Температура среды	max. 50 °C
Уплотнение	Нитрильный каучук
Корпус	Die-cast zinc
Пружинная крышка	POM-brass
Измерение расхода воздуха	At P1 = 10 bar, P2 = 6 bar and pressure drop $\Delta p = 1$ bar

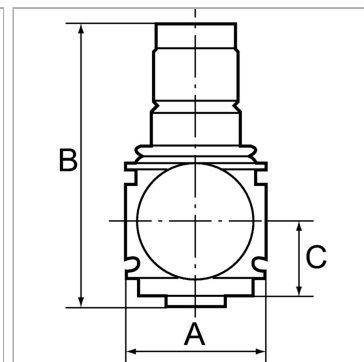

Информация о продукте

Резьба	G 3/8
Диапазон регулирования	0.5 - 10 bar
Расход пот.	1800 l/min

C	26 mm
A	48 mm
B	98,0 mm

Указания

Прочие данные только по запросу.

Описание

Diaphragm pressure regulators with self-relieving design for mounting side by side. The pressure setting can be locked by pushing the knob down. By assembling two or more controllers together, it is possible to supply several working air circuits with different output pressures via a single supply line.

Указание по заказу

Pressure regulators are also available in lockable version. Please ask for more information.