

Характеристики

Входное давление	Max. 25 bar
Температура среды	max. 50 °C
Температура окружающей среды	max. 50 °C
Уплотнение	Нитрильный каучук
Мембрана	NBR
Корпус	Die-cast zinc
Пружинная крышка	POM
Измерение расхода воздуха	At P1 = 10 bar, P2 = 6 bar and pressure drop $\Delta p = 1$ bar

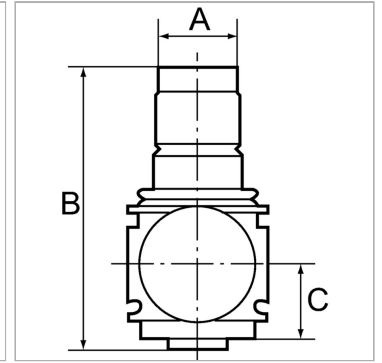

Информация о продукте

Резьба	G 1/2
Диапазон регулирования	0.5 - 16 bar
Расход пот.	7000 l/min

C	32.5 mm
A	70 mm
B	134,0 mm

Указания

Прочие данные только по запросу.

Описание

Reversible diaphragm pressure regulators, independent of inlet pressure, with self-relieving design. The pressure setting can be locked by pushing the knob down. Approved series in modern industrial design, with the following key benefits: Simple handling, Convenient modular assembly thanks to innovative fasteners, Excellent flow values.

Указание по заказу

Pressure regulators are also available in lockable version. Please ask for more information.