

Inline pressure regulators, 2 x female thread, self-relieving

Обновлено: 04.24.24

Характеристики

Область температур	0 °C to +80 °C
Рабочее давление	Max. 25 bar
Корпус	Aluminium
остальные детали	Stainless steel, nitrile rubber, brass

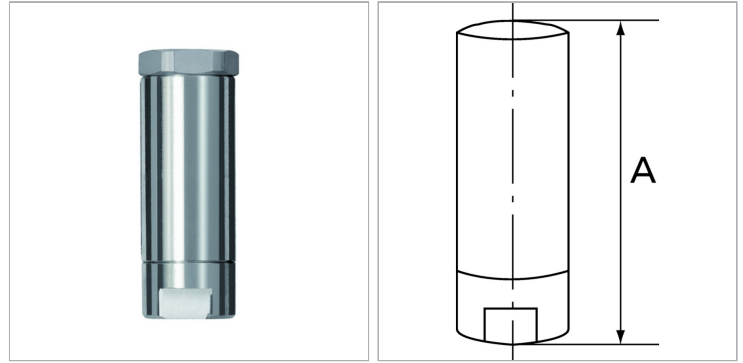

Информация о продукте

Резьба	G 1/4
Рабочее давление, предварительно настроенное	4.0 bar
Расход	600 - 800 l/min

Расход	600 - 800 l/min
SW	16 mm
A	56.6 mm

Указания

Прочие данные только по запросу.

Описание

The majority of pneumatic tools are connected directly to the compressed air supply by means of a quick disconnect coupling, in other words they tend to be supplied with a higher pressure than is actually required. Which increases consumption and leads to tool overload. Added safety is provided by the automatic self-relieving function. If the tool is disconnected from the hose, it continues to work for a short period, even though it has been switched off, owing to the residual pressure that is present on the tool side.

Inadvertent operation of the tool can thus lead to serious injuries to the user (tackers or nail drivers can fire up to another ten shots).

This effect can be prevented by using the inline pressure regulators, which have a preset pressure determined by the application, thereby achieving energy efficiency and economy.