

Характеристики

Входное давление	Max. 15 bar
Соединение	G 1/4 internal / external
Материал	Латунь

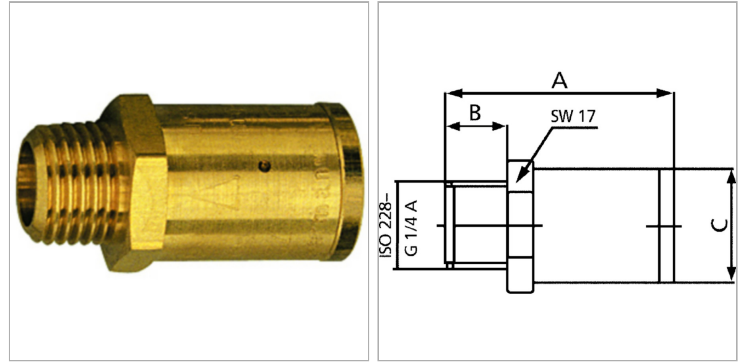

Информация о продукте

Установочное давление	6
макс.: расход	405 l/min
SW	17 mm

A	34 mm
B	9,0 mm
Ø C	17 mm

Указания

Прочие данные только по запросу. Dependent on the input pressure P1, the initial pressure P2 can vary between -20% to +20%

Описание

Industry, trade and repair shops often require working pressures of 15 bar or less. These pressure reducing valves, which are screwed directly onto the tool, enable the actually necessary working pressure to be set.

Benefits: Significantly reduced risk of accidents, Longer tool life with fewer malfunctions, Lower noise levels at the workplace.