

## Pressure regulators with pressure supply at both ends

Обновлено: 04.28.24

### Характеристики

<b>Входное давление</b>	Max. 16 bar
<b>Температура окружающей среды</b>	Max. 60 °C
<b>Температура среды</b>	Max. 60 °C
<b>Уплотнение</b>	Нитрильный каучук
<b>Корпус</b>	Die-cast zinc
<b>Пружинная крышка</b>	POM-brass
<b>Измерение расхода воздуха</b>	At P1 = 8 bar, P2 = 6 bar and pressure drop $\Delta p = 1$ bar

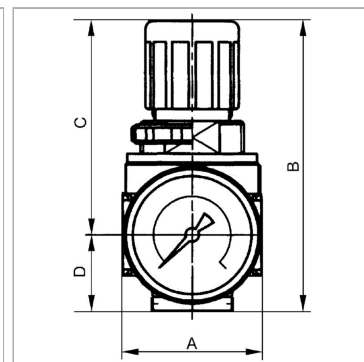

### Информация о продукте

<b>Резьба</b>	G 1/4
<b>Диапазон регулирования</b>	0.2 - 6 bar
<b>Расход пот.</b>	1200 l/min
<b>C</b>	63 mm
<b>DN</b>	5

<b>DN</b>	5
<b>A</b>	40 mm
<b>B</b>	85,0 mm
<b>D</b>	22 mm
<b>Типоразмер</b>	0

DN = номинальный диаметр, номинальный внутренний диаметр

### Указания

Прочие данные только по запросу.

### Описание

Diaphragm pressure regulators with self-relieving design for mounting side by side. The pressure setting can be locked by pushing the button down.

By assembling two or more controllers together, it is possible to supply several working air circuits with different output pressures via a single supply line.

### Указание по заказу

The port for the output pressure (P2) is on the rear! K-07250028: G 1/8. Lockable pressure regulator: K-07250027. If several devices in the »multifix-mini« Series are assembled together, the maximum working pressure is 12 bar.