

Характеристики

Рабочее давление	макс. 10 бар
Расход 6,3 бар, p=1 бар	400 NI/min (Ø 6), 790 NI/min (Ø 8)
Подключение управляющего воздуха	4 mm
Область температур	-20 °C to +60 °C
Корпус	Technopolymer
Внутренние детали	nickel-plated brass, brass, technopolymer, stainless steel
Уплотнение	Нитрильный каучук
Монтаж	Wall mounting (housing with drilled holes) Bracket mounting (mounting bracket available) Panel mounting (with bracket or lock nut)
Дополнительная информация	Symbol auf dem Gehäuse Ventilfunktion NC

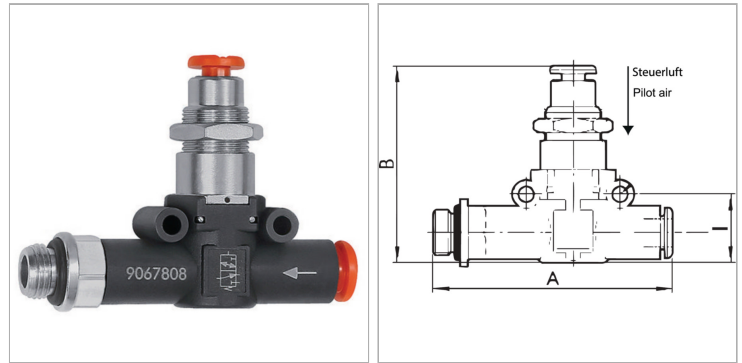

Информация о продукте

Резьба для шланга Ø	G 1/8
В	43.2 mm

В	43.2 mm
l	14.6 mm
A	58.5 mm

Указания

Прочие данные только по запросу.

Описание

A carefully selected assortment of products for installation in pneumatic circuits. These small, highly efficient components allow all pneumatic functions to be implemented anywhere in the circuit. The series has an ultramodular design.

All components can be installed in parallel, in series, in a mixed parallel / serial configuration. Available as Pipe / pipe connection with two plug connectors Thread / pipe connection, with one plug connector and one nickel-plated brass thread.

Дополнительная информация

Symbol on the housing Valve function NC