

### Характеристики

<b>Рабочее давление</b>	Max. 10 bar
<b>Управляющее давление</b>	1 - 5 bar, depending on operating pressure
<b>Температура среды</b>	Max. 70 °C
<b>Расположение</b>	Any. Ring pieces can still be rotated 360° after the valve has been tightened
<b>Уплотнение</b>	Пербунан

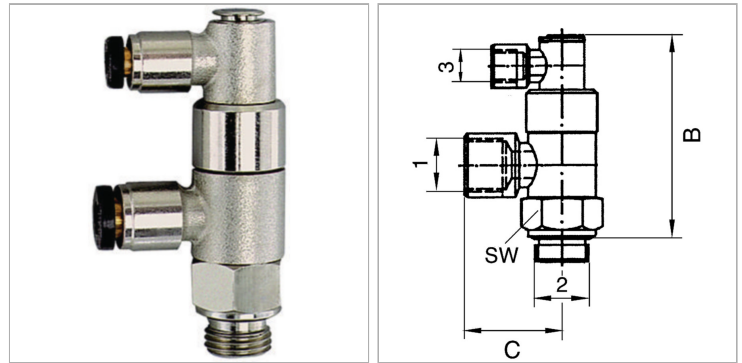

### Информация о продукте

<b>Материал</b>	Никелированная латунь
<b>Port 2</b>	6 mm
<b>Port 1</b>	G 1/8"
<b>Соединение 3</b>	4 mm

<b>Соединение 3</b>	4 mm
<b>Материал</b>	Никелированная латунь
<b>C</b>	25 mm
<b>B</b>	52 mm

### Указания

Прочие данные только по запросу.

### Описание

For high-speed positioning and stop functions as well as emergency switching (e.g. emergency stop). If a control signal is present at port 3, air can flow to and from the cylinder. If no control signal is present, the air flow to and from the cylinder is shut off, causing the cylinder to stop in the required position. Stop valves are screwed directly onto the cylinder instead of the normal pipe connections.