

## Round cylinders, double-acting, with magnet, non-cushioned, »MI« Series

Обновлено: 04.28.24

### Характеристики

<b>Рабочие среды</b>	Filtered, unlubricated or lubricated compressed air. If lubrication is used, it must be continuous.
<b>Рабочее давление</b>	1 - 10 bar (double-acting); 2 - 10 bar (single-acting)
<b>Область температур</b>	-20 °C to +70 °C
<b>Поршневой шток</b>	Stainless steel 1.4301
<b>Исполнение</b>	Type "CA" = ground cover with threaded pin - swivel design Type "CM" = ground cover with threaded pin round - swivel design
<b>Поршни</b>	Stainless steel 1.4305 (8 to 12 mm); Alu (16 to 40 mm)
<b>Труба цилиндра</b>	Stainless steel 1.4301
<b>Уплотнение</b>	Нитрильный каучук

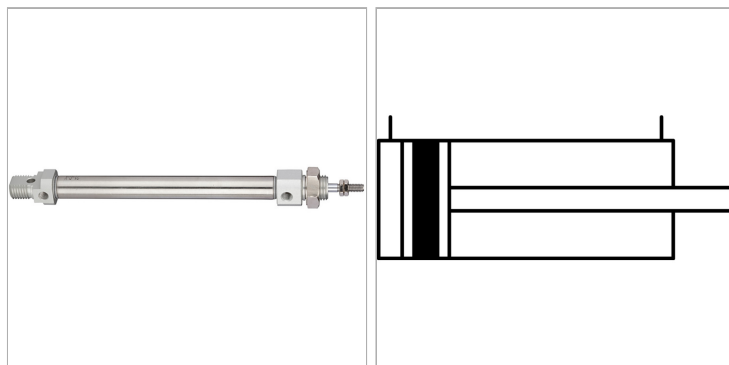

### Информация о продукте

<b>Ø поршня</b>	40 mm	<b>Ø поршневого штока</b>	16 mm
<b>Ход</b>	160 mm	<b>Исполнение</b>	»CM« type
<b>Ø поршневого штока</b>	16 mm	<b>Внешняя резьба поршневого штока</b>	M 12 x 1,25

### Указания

Прочие данные только по запросу.

### Описание

Circular cylinder in stainless steel in different versions: Series "MI" double-acting, Ø 8 - 25 in accordance with ISO 6432 Series "MI" double-acting, Ø 32 - 40