

Характеристики

Рабочие среды	Filtered, unlubricated or lubricated compressed air. If lubrication is used, it must be continuous.
Рабочее давление	1 - 10 bar (double-acting); 2 - 10 bar (single-acting)
Область температур	-20 °C to +70 °C
Поршневой шток	Stainless steel 1.4301
Исполнение	Type "CA" = ground cover with threaded pin - swivel design Type "CM" = ground cover with threaded pin round - swivel design
Поршни	Stainless steel 1.4305 (8 to 12 mm); Alu (16 to 40 mm)
Труба цилиндра	Stainless steel 1.4301
Уплотнение	Нитрильный каучук

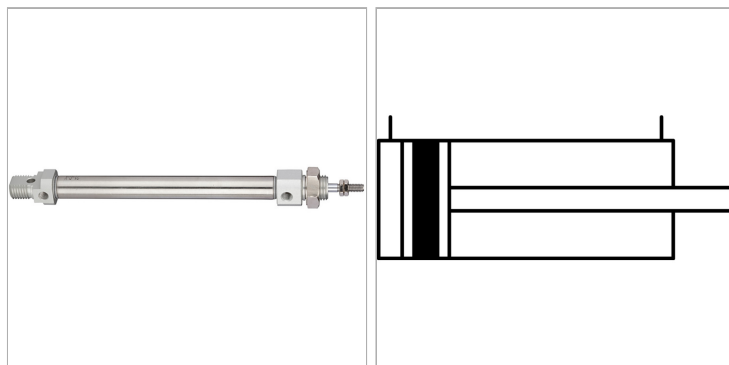

Информация о продукте

Ø поршня	10 mm
Ход	160 mm
Ø поршневого штока	4 mm

Ø поршневого штока	4 mm
Исполнение	»CA« type, acc. to ISO 6432
Внешняя резьба поршневого штока	M 4 x 0,7

Указания

Прочие данные только по запросу.

Описание

Circular cylinder in stainless steel in different versions: Series "MI" double-acting, Ø 8 - 25 in accordance with ISO 6432 Series "MI" double-acting, Ø 32 - 40