

Miniature cylinders, double acting (magnetic, non-cushioned)

Характеристики

Рабочие среды	Filtered, unlubricated or lubricated compressed air. If lubrication is used, it must be continuous.
Рабочее давление	Max. 10 bar
Область температур	-10 °C to +80 °C
Давление реагирования	0.8 bar (Ø 8 to Ø 12), 0.6 bar (Ø 16 to Ø 25)
Поршневой шток	C45 steel, hard chrome-plated
Монтаж	Flanged joint between stainless steel barrel and heads
Труба	Stainless steel 1.4301
Поршни	Synthetic (acetal) resin
Уплотнение	Нитрильный каучук
Дополнительная информация	Wichtiger Hinweis: Stecker im Lieferumfang nicht enthalten. Bitte separat mitbestellen.

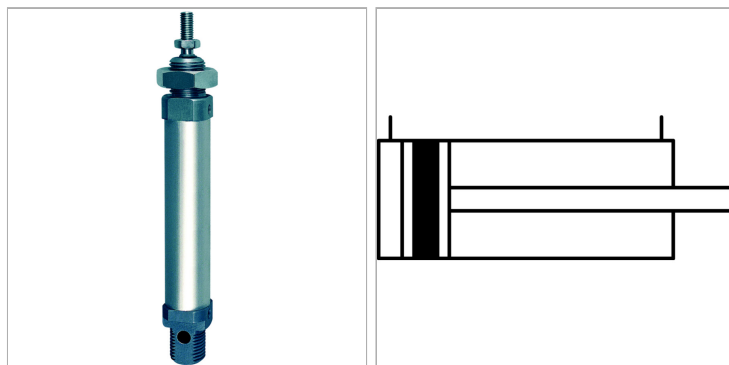

Информация о продукте

Ø поршня	20 mm	Соединение	G 1/8"
Ход	250 mm	Резьба поршневого штока	M 8

Указания

Прочие данные только по запросу. Maximum recommended stroke: Double-acting: Ø 8 - Ø 10 = 100 stroke, Ø 12 - Ø 16 = 200 stroke, Ø 20 - Ø 25 = 250 stroke. Single-acting: Ø 8 - Ø 25 = 50 stroke. Longer stroke lengths can cause operational malfunctions.

Описание

Single and double-acting cylinders, with magnetic piston.

Дополнительная информация

Important: The scope of supply does not include a connector. Please order separately.