

## Miniature cylinders, double acting (magnetic, non-cushioned)

### Характеристики

<b>Рабочие среды</b>	Filtered, unlubricated or lubricated compressed air. If lubrication is used, it must be continuous.
<b>Рабочее давление</b>	Max. 10 bar
<b>Область температур</b>	-10 °C to +80 °C
<b>Давление реагирования</b>	0.8 bar (Ø 8 to Ø 12), 0.6 bar (Ø 16 to Ø 25)
<b>Поршневой шток</b>	C45 steel, hard chrome-plated
<b>Монтаж</b>	Flanged joint between stainless steel barrel and heads
<b>Труба</b>	Stainless steel 1.4301
<b>Поршни</b>	Synthetic (acetal) resin
<b>Уплотнение</b>	Нитрильный каучук
<b>Дополнительная информация</b>	Wichtiger Hinweis: Stecker im Lieferumfang nicht enthalten. Bitte separat mitbestellen.

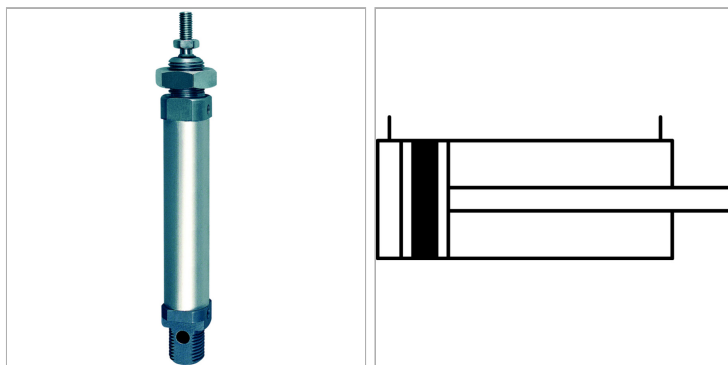

### Информация о продукте

<b>Ø поршня</b>	20 mm	<b>Соединение</b>	G 1/8"
<b>Ход</b>	80 mm	<b>Резьба поршневого штока</b>	M 8

### Указания

Прочие данные только по запросу. Maximum recommended stroke: Double-acting: Ø 8 - Ø 10 = 100 stroke, Ø 12 - Ø 16 = 200 stroke, Ø 20 - Ø 25 = 250 stroke. Single-acting: Ø 8 - Ø 25 = 50 stroke. Longer stroke lengths can cause operational malfunctions.

### Описание

Single and double-acting cylinders, with magnetic piston.

### Дополнительная информация

Important: The scope of supply does not include a connector. Please order separately.