

### Характеристики

<b>Рабочие среды</b>	Filtered, unlubricated or lubricated compressed air. If lubrication is used, it must be continuous.
<b>Рабочее давление</b>	Max. 10 bar
<b>Область температур</b>	-20 °C to +70 °C (Ø 32 to Ø 63) -10 °C to +70 °C (Ø 80 to Ø 125)
<b>Давление реагирования</b>	0.4 bar (Ø 32 to Ø 40), 0.3 bar (Ø 50 to Ø 63), 0.2 bar (Ø 80 to Ø 125)
<b>Поршневой шток</b>	C45 steel, hard chrome-plated
<b>Монтаж</b>	Heads / jacket with self-tapping screws
<b>Труба</b>	Anodised aluminium jacket with integrated T-slots
<b>Поршни</b>	POM (Ø 20 to Ø 63); Aluminium (Ø 80 to Ø 125)
<b>Уплотнение</b>	Нитрильный каучук

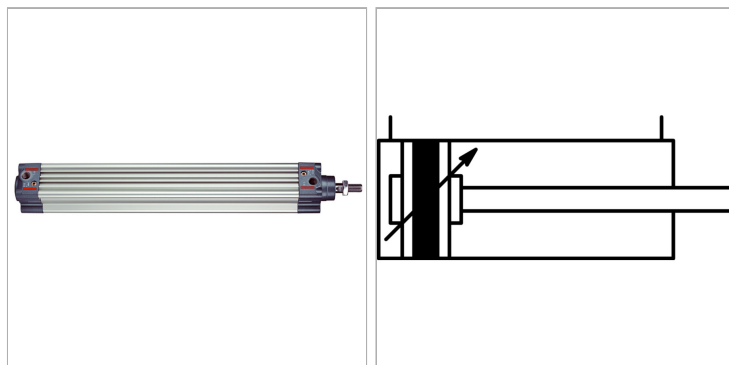

### Информация о продукте

<b>Ø поршня</b>	63 mm	<b>Соединение</b>	G 3/8"
<b>Ход</b>	250 mm	<b>Ø поршневого штока</b>	20 mm
<b>Соединение</b>	G 3/8"	<b>Внешняя резьба поршневого штока</b>	M 16 x 1,5

### Указания

Прочие данные только по запросу.

### Описание

These cylinders are ideal for a wide range of applications owing to their robust design and excellent value for money. The standard type has a double-acting cylinder and features a magnetic piston as well as integrated cushioning. The magnetic switches can be mounted in two T-slots on the same side as the compressed air supply.

Cylinders of the same type can also be supplied on request with fixing parts for magnetic switches on three sides.

The version with a 125 mm bore is provided with fixing accessories on three sides as standard.