

Характеристики

Рабочие среды	Filtered, unlubricated or lubricated compressed air. If lubrication is used, it must be continuous.
Рабочее давление	1 - 10 bar
Область температур	-20 °C to +80 °C
Поршневой шток	gehärteter Stahl, hartverchromt
Труба	Aluminium jacket with integrated T-slots
Поршни	алюминий
Уплотнение	TPU
Набивочный материал уплотнительного кольца	NBR
Дополнительная информация	Wichtiger Hinweis: Stecker im Lieferumfang nicht enthalten. Bitte separat mitbestellen. Hub 1000 lieferbar auf Anfrage.

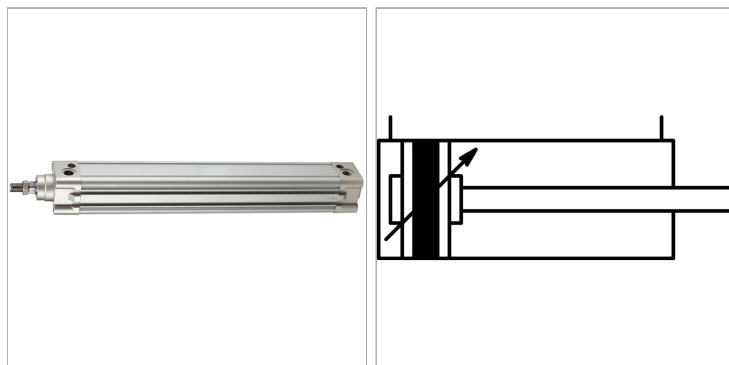

Информация о продукте

Ø поршня	80 mm	Соединение	G 3/8"
Ход	500 mm	Ø поршневого штока	25 mm
Соединение	G 3/8"	Внешняя резьба поршневого штока	M 20 x 1,5

Указания

Прочие данные только по запросу.

Описание

These cylinders are ideal for a wide range of applications owing to their robust design and excellent value for money.

The standard type has a double-acting cylinder and features a magnetic piston as well as integrated cushioning. The magnetic switches are mounted in T-slots on three sides of the body.

Дополнительная информация

Important: The scope of supply does not include a connector. Please order separately. Stroke 1000 available on request.