

Характеристики

Рабочие среды	Filtered, unlubricated or lubricated compressed air. If lubrication is used, it must be continuous.
Рабочее давление	1 - 10 bar
Область температур	-20 °C to +80 °C
Поршневой шток	gehärteter Stahl, hartverchromt
Труба	Aluminium jacket with integrated T-slots
Поршни	алюминий
Уплотнение	TPU
Набивочный материал уплотнительного кольца	NBR
Дополнительная информация	Wichtiger Hinweis: Stecker im Lieferumfang nicht enthalten. Bitte separat mitbestellen. Hub 1000 lieferbar auf Anfrage.

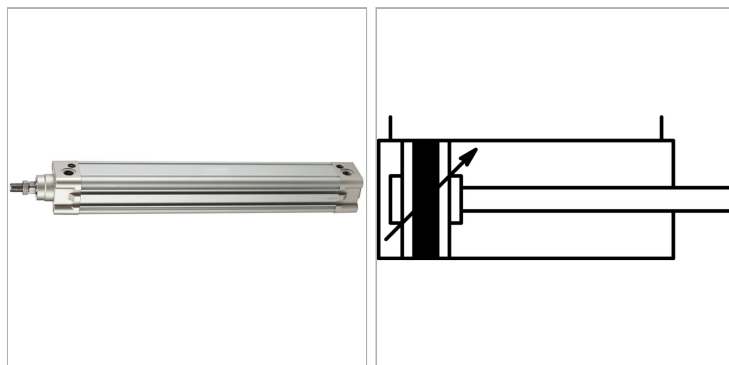

Информация о продукте

Ø поршня	40 mm
Ход	100 mm
Соединение	G 1/4"

Соединение	G 1/4"
Ø поршневого штока	16 mm
Внешняя резьба поршневого штока	M 12 x 1,25

Указания

Прочие данные только по запросу.

Описание

These cylinders are ideal for a wide range of applications owing to their robust design and excellent value for money.

The standard type has a double-acting cylinder and features a magnetic piston as well as integrated cushioning. The magnetic switches are mounted in T-slots on three sides of the body.

Дополнительная информация

Important: The scope of supply does not include a connector. Please order separately. Stroke 1000 available on request.