

### Характеристики

<b>Рабочие среды</b>	Filtered, unlubricated or lubricated compressed air. If lubrication is used, it must be continuous.
<b>Рабочее давление</b>	1 - 10 bar
<b>Область температур</b>	-20 °C to +80 °C
<b>Поршневой шток</b>	gehärteter Stahl, hartverchromt
<b>Труба</b>	Aluminium jacket with integrated T-slots
<b>Поршни</b>	алюминий
<b>Уплотнение</b>	TPU
<b>Набивочный материал уплотнительного кольца</b>	NBR
<b>Дополнительная информация</b>	Wichtiger Hinweis: Stecker im Lieferumfang nicht enthalten. Bitte separat mitbestellen. Hub 1000 lieferbar auf Anfrage.

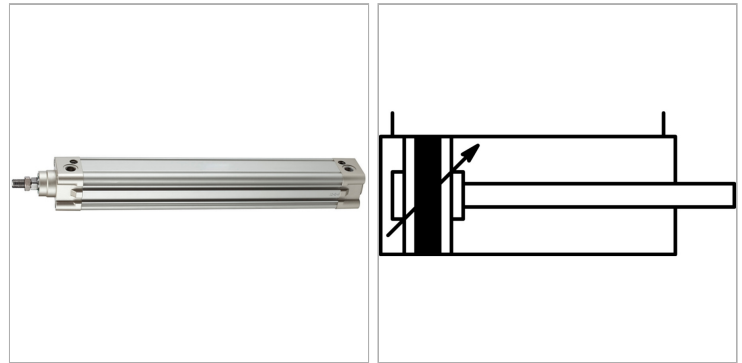

### Информация о продукте

<b>Ø поршня</b>	40 mm
<b>Ход</b>	25 mm
<b>Соединение</b>	G 1/4"

<b>Соединение</b>	G 1/4"
<b>Ø поршневого штока</b>	16 mm
<b>Внешняя резьба поршневого штока</b>	M 12 x 1,25

### Указания

Прочие данные только по запросу.

### Описание

These cylinders are ideal for a wide range of applications owing to their robust design and excellent value for money.

The standard type has a double-acting cylinder and features a magnetic piston as well as integrated cushioning. The magnetic switches are mounted in T-slots on three sides of the body.

### Дополнительная информация

Important: The scope of supply does not include a connector. Please order separately. Stroke 1000 available on request.