

## 3/2-way toggle valves, discharge port on thread, plug-in connector

### Характеристики

<b>Рабочее давление</b>	макс. 8 бар
<b>Область температур</b>	0 °C to +70 °C
<b>Резьба на стороне распределительного щита</b>	M 12 x 0.75 (sheet thickness max. 4 mm)
<b>Внутренние детали</b>	Brass with a bare metal surface
<b>Уплотнение</b>	Нитрильный каучук
<b>Полый винт, поворотный рычаг, коромысло</b>	Nickel-plated brass
<b>Уплотнения (неотделимые)</b>	Polyamide (glass fibre-reinforced)

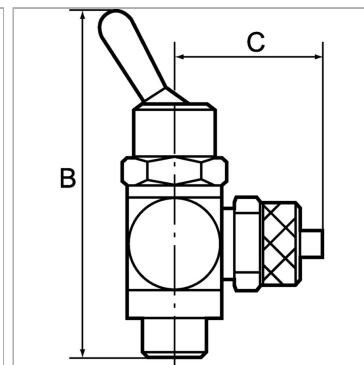

### Информация о продукте

<b>C</b>	22 mm
<b>Для шланга</b>	6 mm
<b>Резьба</b>	G 1/8

<b>SW</b>	14 mm
<b>Исполнение</b>	3/2-way
<b>B</b>	55 mm

### Указания

Прочие данные только по запросу.

### Описание

Manually operated toggle valves, 2/2 and 3/2-way types. For all applications where compressed air must be switched on or off quickly and easily or a cylinder operated manually. Designed as a banjo-type valve with a hollow bolt and ring piece. Suitable for screwing directly into the equipment or for panel mounting. Compact type of construction, also ideal where space is restricted.