

3/2-way toggle valves, discharge port on thread, plug-in connector

Характеристики

Рабочее давление	макс. 8 бар
Область температур	0 °C to +70 °C
Резьба на стороне распределительного щита	M 12 x 0.75 (sheet thickness max. 4 mm)
Внутренние детали	Brass with a bare metal surface
Уплотнение	Нитрильный каучук
Полый винт, поворотный рычаг, коромысло	Nickel-plated brass
Уплотнения (неотделимые)	Polyamide (glass fibre-reinforced)

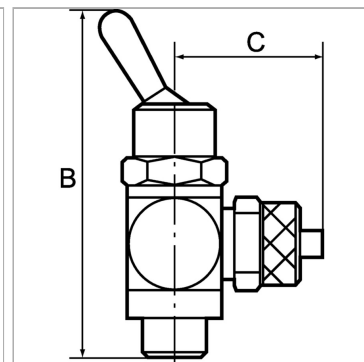

Информация о продукте

C	23.5 mm
Для шланга	6 mm
Резьба	G 1/4

SW	17 mm
Исполнение	3/2-way
B	60 mm

Указания

Прочие данные только по запросу.

Описание

Manually operated toggle valves, 2/2 and 3/2-way types. For all applications where compressed air must be switched on or off quickly and easily or a cylinder operated manually. Designed as a banjo-type valve with a hollow bolt and ring piece. Suitable for screwing directly into the equipment or for panel mounting. Compact type of construction, also ideal where space is restricted.