

2/2-way toggle valves, discharge port on both sides, plug-in connector

Обновлено: 04.27.24

Характеристики

Рабочее давление	макс. 8 бар
Область температур	0 °C to +70 °C
Резьба на стороне распределительного щита	M 12 x 0.75 (sheet thickness max. 4 mm)
Внутренние детали	Brass with a bare metal surface
Уплотнение	Нитрильный каучук
Полый винт, поворотный рычаг, коромысло	Nickel-plated brass
Уплотнения (неотделимые)	Polyamide (glass fibre-reinforced)

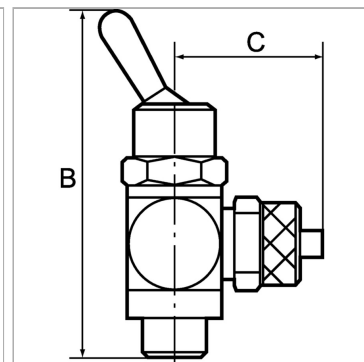

Информация о продукте

C	19.5 mm
Для шланга	4 mm
Резьба	G 1/8

SW	14 mm
Исполнение	2/2-way
B	55 mm

Указания

Прочие данные только по запросу.

Описание

Manually operated toggle valves, 2/2 and 3/2-way types. For all applications where compressed air must be switched on or off quickly and easily or a cylinder operated manually. Designed as a banjo-type valve with a hollow bolt and ring piece. Suitable for screwing directly into the equipment or for panel mounting. Compact type of construction, also ideal where space is restricted.