

Unidirectional banjo valves, pneumatic release, port 2 with female thread

Обновлено: 04.24.24

Характеристики

Рабочее давление	0.3 - 10 bar
Управляющее давление	0.5 - 2.5 bar, depending on operating pressure
Температура среды	Max. 60 °C
Расположение	Any. The ring piece must be positioned before the valve is tightened
Материал	Никелированная латунь
Уплотнение	Пербунан

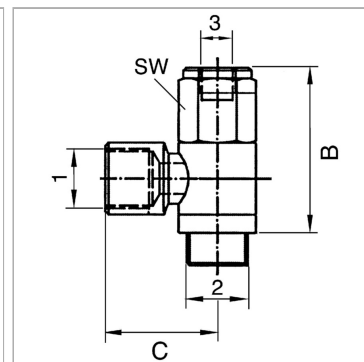

Информация о продукте

Port 2	G 1/4"
Port 1	G 1/4"
Соединение 3	G 1/8"

Соединение 3	G 1/8"
C	25.4 mm
B	43 mm

Указания

Прочие данные только по запросу.

Описание

For stopping and positioning the cylinder movement: If a control signal is present at port 3 (see drawing), air can flow to and from the cylinder. If no control signal is present, the cylinder exhaust air is shut off by the unidirectional valve.

The cylinder is stopped. Releasable unidirectional valves are screwed directly onto the cylinder instead of the normal pipe connections.