

Bidirectional flow control valves, air restriction at both ends (»B«), plug-in connector

Обновлено: 04.20.24

Характеристики

Рабочее давление	макс. 10 бар
Область температур	0 °C to +70 °C
Польный винт, поворотный рычаг, регулировочный винт	Nickel-plated brass
Внутренние детали	Brass with a bare metal surface
Уплотнения (неотделимые)	Polyamide (glass fibre-reinforced)
Дополнительная информация	NBR Lippendichtung O-Ring

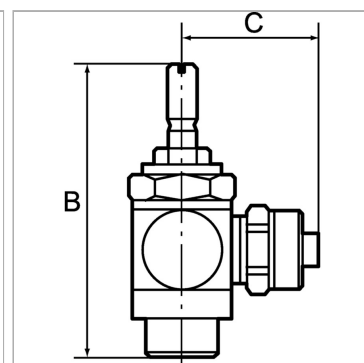

Информация о продукте

C	24.7 mm
Для шланга	8 mm
SW	17 mm

SW	17 mm
Резьба	G 1/4
B	51 mm

Указания

Прочие данные только по запросу.

Описание

For regulation of a cylinder piston speed at both ends and control of flow rates. Designed as a banjo-type valve with a hollow bolt and ring piece for mounting directly.

On the version with a knurled screw, the set volumetric flow rate can be locked with the hexagon nut to obtain a fixed setting.

Дополнительная информация

NBR lip seal O-ring