

Unidirectional flow control valves, outgoing air restriction (»C«), quick-lock screw fitting

Обновлено: 04.26.24

Характеристики

Рабочее давление	макс. 10 бар
Область температур	0 °C to +70 °C
Польный винт, поворотный рычаг, регулировочный винт	Nickel-plated brass
Внутренние детали	Brass with a bare metal surface
Уплотнения (неотделимые)	Polyamide (glass fibre-reinforced)
Дополнительная информация	NBR Lippendichtung O-Ring

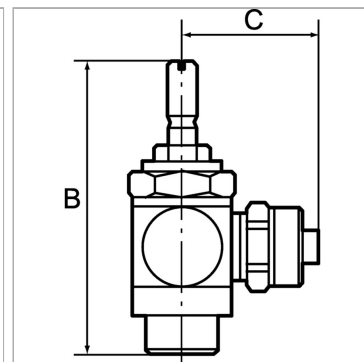

Информация о продукте

C	19 mm
Для шланга	6 mm / 4 mm
Резьба	M 5

Резьба	M 5
SW	8 mm
B	38.9 mm

Указания

Прочие данные только по запросу.

Описание

For fine regulation of a cylinder piston speed and precise control of flow rates. Designed as a banjo-type valve with a hollow bolt and ring piece. Can be screwed directly onto the valve or cylinder. Compact type of construction, also ideal where space is restricted. On the version with a knurled screw, the set volumetric flow rate can be locked with the hexagon nut to obtain a fixed setting.

Дополнительная информация

NBR lip seal O-ring