

### Характеристики

<b>Материал</b>	Galvanised steel
<b>Рабочее давление</b>	макс. 700 бар

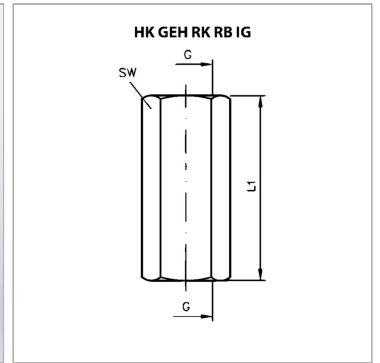

### Информация о продукте

<b>L1</b>	56 mm
<b>G</b>	G 1/2"

<b>G</b>	G 1/2"
<b>SW</b>	27 mm