

Характеристики

Материал Сталь S355J0 (Fe510C)

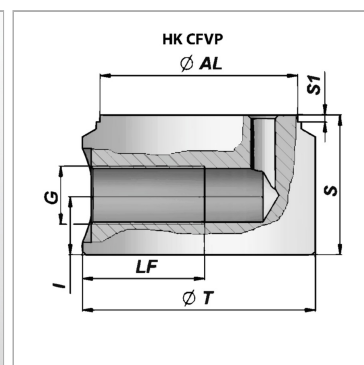

Информация о продукте

Ø AL 50 mm

Ø T 60 mm

S1 2 mm

LF 35 mm

LF 35 mm

I 17 mm

G G 3/8"

S 40 mm