

### Характеристики

**Материал** Сталь S355J0 (Fe510C)

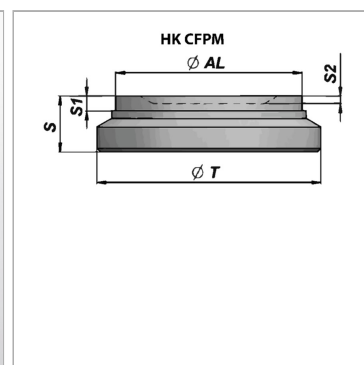
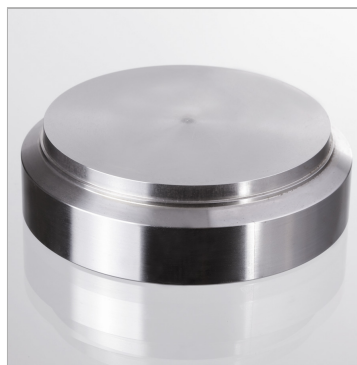

### Информация о продукте

**Ø AL** 110 mm

**Ø T** 125 mm

**S1** 7 mm

**S** 36 mm