

Характеристики

Материал Сталь S355J0 (Fe510C)

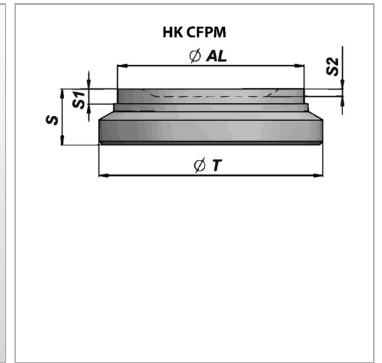
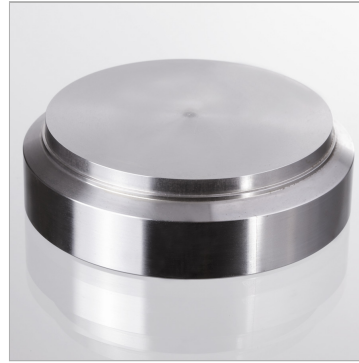

Информация о продукте

Ø AL 70 mm

Ø T 85 mm

S2 2 mm

S2 2 mm

S1 4 mm

S 22 mm