

### Характеристики

**Материал** Сталь S355J0 (Fe510C)

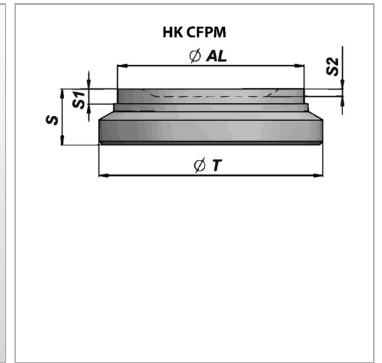
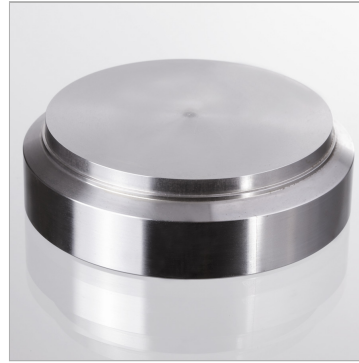

### Информация о продукте

**Ø AL** 70 mm

**Ø T** 80 mm

**S1** 4 mm

**S** 24 mm