

Характеристики

Материал Сталь S355J0 (Fe510C)

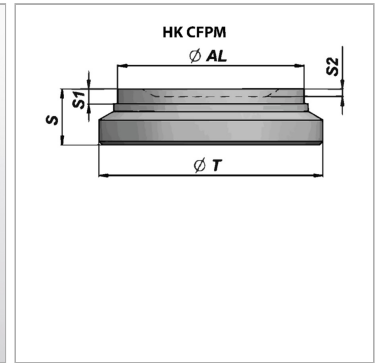
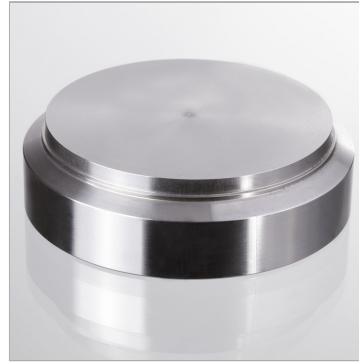

Информация о продукте

Ø AL 60 mm

Ø T 70 mm

S1 4 mm

S 21 mm