

Характеристики

Материал Сталь S355J0 (Fe510C)

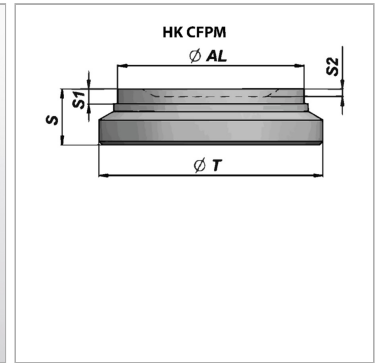
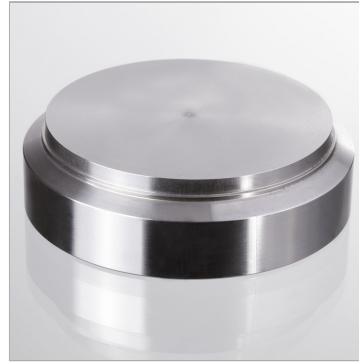

Информация о продукте

Ø AL 50 mm

Ø T 65 mm

S1 4 mm

S 17 mm