

Характеристики

Материал	Сталь S355J0 (Fe510C)
Применение	Suitable for cylinder HK HFR 2S

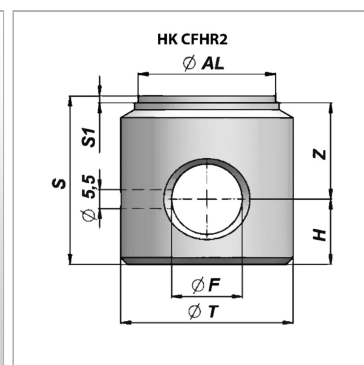

Информация о продукте

Ø AL	160 mm
Ø T	180 mm
Ø F	80.5 mm
S1	2 mm

S1	2 mm
S	140 mm
Z	73 mm
H	65 mm