

Характеристики

Материал	Сталь S355J0 (Fe510C)
Применение	Suitable for cylinder HK HFR 2S

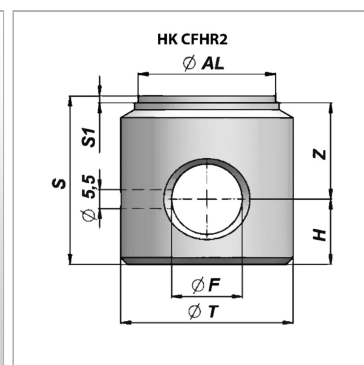

Информация о продукте

Ø AL	120 mm
Ø T	140 mm
Ø F	50.5 mm
S1	2 mm

S1	2 mm
Z	48 mm
S	95 mm
H	45 mm