

Характеристики

Материал	Сталь S355J0 (Fe510C)
Применение	Suitable for cylinder HK HFR 2S

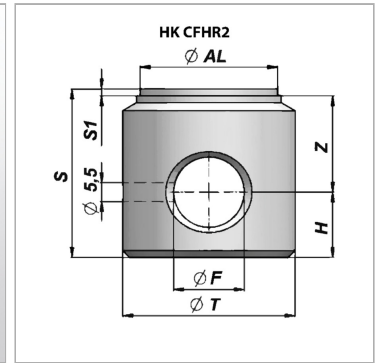
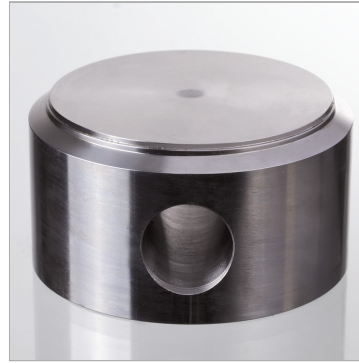

Информация о продукте

Ø AL	110 mm
Ø T	125 mm
Ø F	50.5 mm
S1	2 mm

S1	2 mm
Z	38 mm
S	75 mm
H	35 mm