

Характеристики

Материал	Сталь S355J0 (Fe510C)
Применение	Suitable for cylinder HK HFR 2S

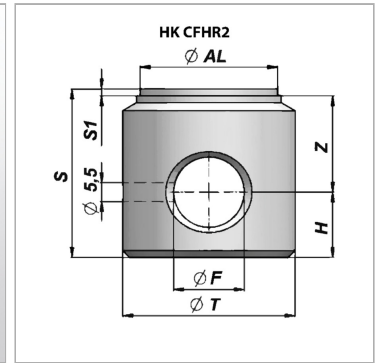
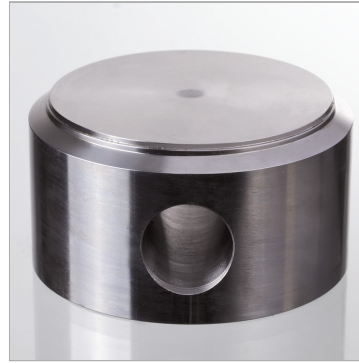

Информация о продукте

Ø AL	90 mm
Ø T	105 mm
Ø F	40.25 mm
S1	2 mm

S1	2 mm
S	63 mm
Z	33 mm
H	28 mm