

### Характеристики

<b>Материал</b>	Сталь S355J0 (Fe510C)
<b>Применение</b>	Suitable for cylinder HK HFR 2S

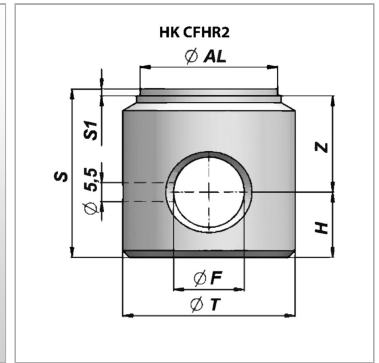
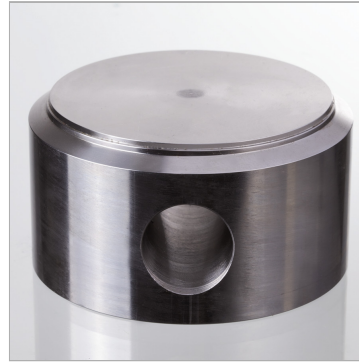

### Информация о продукте

<b>Ø AL</b>	80 mm
<b>Ø T</b>	90 mm
<b>Ø F</b>	40.25 mm
<b>S1</b>	2 mm

<b>S1</b>	2 mm
<b>Z</b>	30 mm
<b>S</b>	60 mm
<b>H</b>	28 mm