

Характеристики

Материал	Сталь S355J0 (Fe510C)
Применение	Suitable for cylinder HK HFR 2S

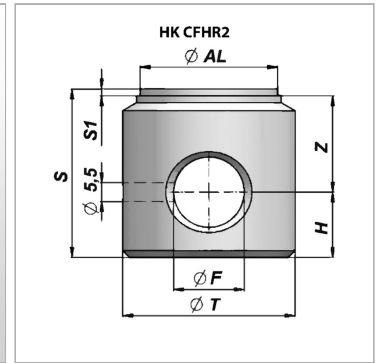
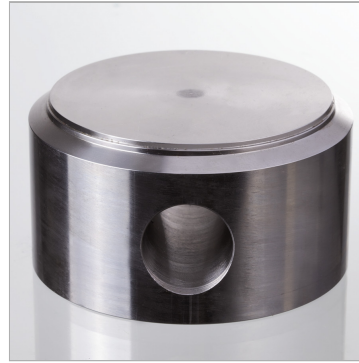

Информация о продукте

Ø AL	60 mm
Ø T	70 mm
Ø F	30.25 mm
S1	2 mm

S1	2 mm
S	47 mm
Z	23 mm
H	22 mm