

Характеристики

Материал	Сталь S355J0 (Fe510C)
Применение	Suitable for cylinder HK HFR 2S

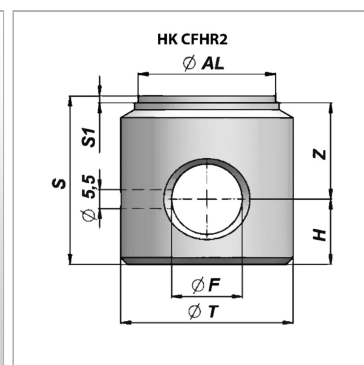

Информация о продукте

Ø AL	40 mm
Ø T	50 mm
Ø F	20.25 mm
S1	2 mm

S1	2 mm
Z	20 mm
S	40 mm
H	18 mm