

Характеристики

Материал	Сталь S355J0 (Fe510C)
Применение	Suitable for cylinder HK HFR

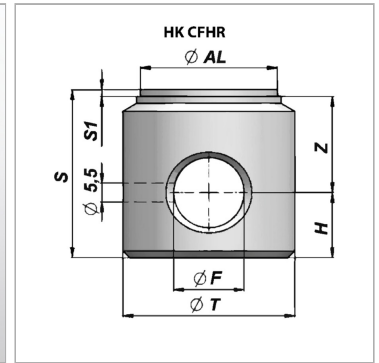
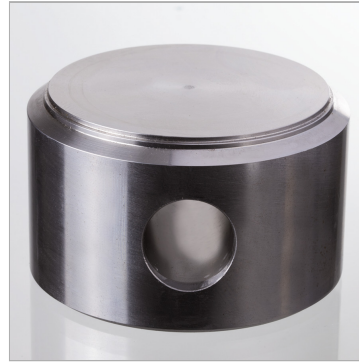

Информация о продукте

Ø AL	70 mm	S1	2 mm
Ø T	80 mm	Z	35 mm
Ø F	30.5 mm	S	62 mm
S1	2 mm	H	25 mm