

Характеристики

Материал Сталь S355J0 (Fe510C)

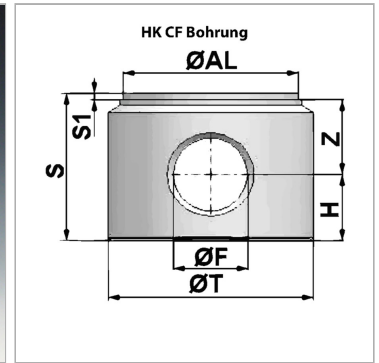

Информация о продукте

Ø AL 70 mm

Ø T 80 mm

Ø F 25.25 mm

S1 2 mm

S1 2 mm

Z 25.5 mm

S 50 mm

H 22.5 mm