

Характеристики

Материал Сталь S355J0 (Fe510C)

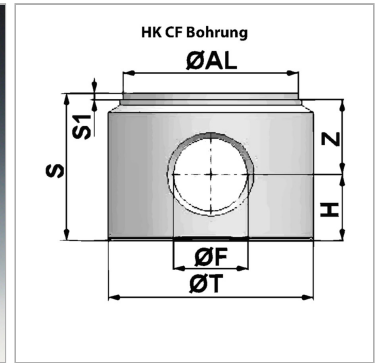

Информация о продукте

Ø AL 50 mm

Ø T 60 mm

Ø F 20.25 mm

S1 2 mm

S1 2 mm

Z 23 mm

S 45 mm

H 20 mm