

Характеристики

Материал	Steel C22
----------	-----------

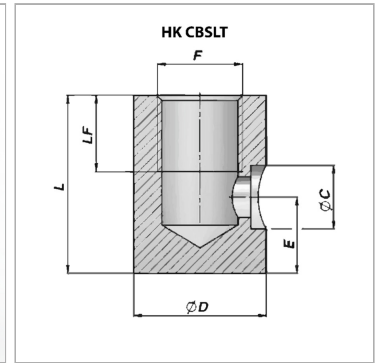

Информация о продукте

E	15 mm
LF	15 mm
F	G 1/2"

Ø D	30 mm
L	35 mm
Ø C	15.5 mm