

Характеристики

Материал	Steel C22
----------	-----------

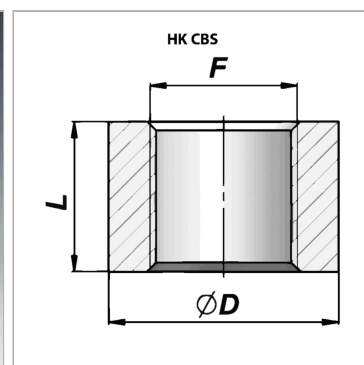

Информация о продукте

F	M 22 x 1,5
Ø D	30 mm

Ø D	30 mm
L	18 mm