

Характеристики

Материал	Steel C22
----------	-----------

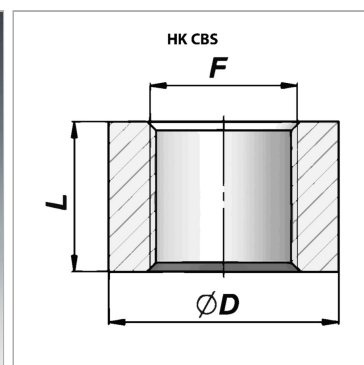

Информация о продукте

F	M 18 x 1,5
Ø D	28 mm

Ø D	28 mm
L	18 mm