

Характеристики

Материал	Steel C22
----------	-----------

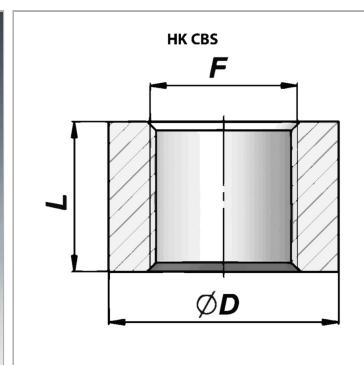

Информация о продукте

F	M 14 x 1,5
Ø D	22 mm

Ø D	22 mm
L	16 mm