

Характеристики

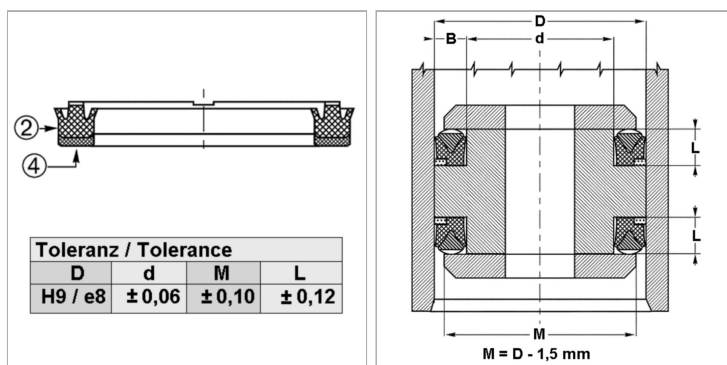

Информация о продукте

D	140 mm
L	16.2 mm

L	16.2 mm
d	115 mm